

WATLOW ELECTRIC MANUFACTURING COMPANY

Installation & Maintenance Manual for Screw Plug Heaters

I&M MANUAL No: 316-42-10-1

Date: 03/15/2017

Page: 1

Rev: 6.00

General Statement

The purpose of this product manual (the “Manual”) is for Watlow Electric Manufacturing Company (“Watlow”) to convey certain recommendations, advisories, and requirements regarding your purchase and use of the product(s) described below (the “Product”). This Manual is not intended to be an exhaustive list of recommendations, advisories, or requirements for the use of the Products. Please visit Watlow’s website (<http://www.watlow.com/>) or contact Watlow customer service (1-800-WATLOW2) for more information regarding Watlow’s products. To ensure the proper use of the Product, each User of the Products should carefully review this Manual. FAILURE TO COMPLY WITH THE INFORMATION PROVIDED HEREIN SHALL CAUSE THE USER TO ASSUME ALL RISK AND LIABILITY ARISING OUT OF SUCH FAILURE.

Table of Contents

General Statement	1
Product Description	1
Safety Statements	2
Safety (Generally).....	3
Pre Installation.....	6
Installation	6
Insulation Resistance (Megohmmeter) Pre-check.....	7
Protection of heater elements from over temperature	7
Electrical Enclosures and Electrical Connection Protection	9
Orientation and Mounting	9
Wiring	13
Start Up	16
Troubleshooting.....	17
Preventative Maintenance	18
Replacement Parts	20
Disposal and Recycling	20
Terms and Conditions and Product Returns	21
Declaration of Conformity (page 1).....	22
Declaration of Conformity (page 2).....	23

Product Description

This document is intended to convey Watlow’s recommendations for Screw Plug / Circulation Heaters designed to the following specifications:

Component Screw Plug heaters, up to 2-1/2” NPT (or equivalent Metric) screw plug of various materials, utilizing WATROD, FIREBAR, FIREROD or MULTICELL heating elements, with or without thermocouple temperature sensor(s), with or without process thermostat, with or without thermowell, with or without terminal enclosures, with or without terminal blocks, rated voltage up to 600 VAC for North America or 1000 VAC @ mains frequency (or 1500 VDC) for the EU, 1 or 3 phase, sheath watt density up to 100 WSI, for use in Ordinary (Non-Classified) Locations only. May be provided with a vessel or circulation tank. See product-number on product label / nameplate. For CE Marked products, see product designation on the back of the Declaration of Conformity.

WATLOW ELECTRIC MANUFACTURING COMPANY

Installation & Maintenance Manual for Screw Plug Heaters

I&M MANUAL No: 316-42-10-1

Date: 03/15/2017

Page: 2

Rev: 6.00

NOTE: Screw Plug heaters are primarily designed to heat liquids in tanks or vessels. However, they can also be used to heat gases and other substances.

NOTE: This style of heater is primarily designed to be powered by the Mains and hence will be operated at a frequency of 50 or 60 hertz. They may optionally be powered by DC.

NOTE: The Operating Current is important for the User to calculate, in order to properly size the feed wire and other components for the safe operation of the heater. Rated Voltage and wattage are provided for this purpose.

NOTE: The rated temperature range is not stated, since this heater is a component in the User's overall system. It is the User's responsibility to keep the electrical enclosure temperature below 50°C (122°F) for units with thermostats. For all other units without a thermostat, the electrical enclosure temperature must be kept below 93°C (200°F). Be sure to read and understand the warnings given in the Electrical Enclosure section of this manual.

Safety Statements

The following markers utilized throughout this Manual shall have the meanings set forth below.



DANGER

This is a Danger statement that is related to the use of this heater. Failure to heed these messages will result in serious personal injury or death.



WARNING

This is a Warning statement that is related to the use of this heater. These statements warn of actions that may result in physical injury or death.



WARNING - Risk of Electric Shock

This is a Warning statement that warns of the presence of electrical voltages which can cause physical injury or death.



CAUTION

This is a Caution statement that is related to the use of this heater. These statements cautions against actions which may damage the heater or associated equipment.

WATLOW ELECTRIC MANUFACTURING COMPANY

Installation & Maintenance Manual for Screw Plug Heaters

I&M MANUAL No: 316-42-10-1

Date: 03/15/2017

Page: 3

Rev: 6.00

Safety (Generally)

The following sets forth general safety requirements and recommendations relating to the use of the Product(s).



WARNING

The User must ensure that the installer uses all relevant PPE (Personal Protection Equipment).



WARNING

This appliance/component is not intended for use by persons (including children) with reduced sensory or mental capabilities, or lack of experience and knowledge, unless they have been given supervision or instruction concerning use of the appliance by a person responsible for their safety. Children should be supervised to ensure that they do not play with the appliance.



WARNING

Electric heaters are inherently dangerous!! Care should be taken to read and completely understand this document before installing and wiring the heater.

Due to the design intent of this component, it will inherently become hot during operation. Therefore, the User must conduct their own Risk assessment to identify if there is any residual risk pertaining to direct contact with hot surfaces.

Due to the weight of some heaters, additional lifting equipment may be required. Use caution whenever handling the heater.



WARNING – Risk of Electric Shock

Any installation and maintenance performed on this heater shall only be done by a qualified electrician, in accordance with applicable national and local electrical codes.

WATLOW ELECTRIC MANUFACTURING COMPANY

Installation & Maintenance Manual for Screw Plug Heaters

I&M MANUAL No: 316-42-10-1

Date: 03/15/2017

Page: 4

Rev: 6.00



WARNING - Risk of Electric Shock

Never interrupt the protective earth circuit / ground.

Any interruption or disconnection of the protective earth circuit used by this heater will create a dangerous situation and could result in an electric shock that in some situations could lead to serious injuries!

If an enclosure is provided, the symbol set forth below indicates where the protective earth ground should be connected in the electrical enclosure of the heater (if not a cast enclosure).



WARNING – Risk of Electric Shock

If a non-cast enclosure is provided, the terminal enclosure cover is bonded to enclosure body to ensure an effective ground fault current path for non-cast enclosure. If this bonding conductor is disconnected for any reason it must be reconnected for safety.

The typical connection utilizes two external tooth lockwashers to sandwich the conductor ring terminal against the connection base and the tightening nut/screw. All hardware must be replaced. Retighten connections to 2.3 N·m (20 in-lb).



WARNING – Risk of Electric Shock

There is potential risk of rupture of the component if the component is not installed as per the manufacturer's installation instructions. Use of over current device(s) is required in accordance with applicable national and local electrical codes.



CAUTION

This product does not fall under the scope of the EMC Directive. However, if the equipment into which this heater is installed falls under the scope of the EMC Directive, it is recommended that the User ensure that their equipment fully complies with all European New Approach Directives as applicable, which may include the EMC Directive.

WATLOW ELECTRIC MANUFACTURING COMPANY

Installation & Maintenance Manual for Screw Plug Heaters

I&M MANUAL No: 316-42-10-1

Date: 03/15/2017

Page: 5

Rev: 6.00



WARNING

It is the User's responsibility to ensure that the heater being used is properly selected and installed in the application. This heater should only be used in the application that it was originally designed for, and failure to do so could result in damage to equipment or injury to personnel! For example, an immersion heater is not likely suitable to be used for heating a gas because the watt density would be too high.

These Heater components must be connected as per the Manufacturers installation instructions and therefore must only be utilized in applications suitable for the use of these components.

Typical applications include –

- Water: Deionized, Demineralized, Clean, Potable
- Industrial water rinse tanks
- Vapor degreasers
- Hydraulic oil, crude, asphalt
- Lubricating oils at API specified watt densities
- Air and gas flow
- Caustic solutions
- Chemical baths
- Process air equipment
- Boiler equipment
- Freeze protection of any fluid
- Anti-freeze (glycol) solutions



WARNING

The User must prevent live conductors from coming into contact with any fluids or personnel.

All original enclosures and covers (where applicable), sensors and/or user controls, etc must be correctly utilized in order for the safe operation of this product.

Warning: this product has not been designed for use in Classified (hazardous) locations.

WATLOW ELECTRIC MANUFACTURING COMPANY

Installation & Maintenance Manual for Screw Plug Heaters

I&M MANUAL No: 316-42-10-1

Date: 03/15/2017

Page: 6

Rev: 6.00

Pre Installation

The following sets forth general safety instructions and requirements relating to the preparation for installation of the product.

Before installing the Product(s), inspect for any damage occurring during shipment, storage or handling. If you have any concerns about the condition of the Product(s), do not install such Product(s) and contact your Watlow representative prior to taking further action with the Product(s).

Before installing the Product(s), confirm that the heater in hand is the same as that which was ordered and which is intended for use. In the event of a discrepancy, please contact your Watlow representative prior to taking further action with the Product(s).



CAUTION

Elements may come in contact with each other during shipment. Minor adjustments to elements may be required prior to installation to separate them. Extensive bending of elements should be avoided since dielectric strength between coil and sheath may be compromised. For FIREBAR elements, Watlow does not recommend field bending of the elements. However, if the element must be bent in the field, please consult your local Watlow representative for assistance

It may be necessary due to atmospheric conditions / humidity, to perform a dielectric test prior to startup. Refer to Insulation Resistance (Megohmmeter) Pre-check under Installation section.

Installation

Proper heater selection and installation will help to ensure heat transfer efficiency, safety, and increased Product life. The following sets forth instructions and requirements relating to the installation of the Product(s).



WARNING

The User must ensure that the installer uses all relevant PPE (Personal Protection Equipment).

WATLOW ELECTRIC MANUFACTURING COMPANY

Installation & Maintenance Manual for Screw Plug Heaters

I&M MANUAL No: 316-42-10-1

Date: 03/15/2017

Page: 7

Rev: 6.00

Insulation Resistance (Megohmmeter) Pre-check



WARNING – Risk of Electric Shock

The bake-out procedures listed below should only be performed by properly qualified personnel. If the procedure calls for connecting electric power to the heater, this shall only be performed by a qualified electrician, in accordance with applicable national and local electrical codes.

During shipping and/or storage, the possibility of moisture absorption by the insulation material within the heater element is possible. To determine if the proper Megohm value is present, use a 500 VDC (minimum) Megohmmeter to measure the dielectric isolation resistance between the heater terminal and the heater sheath. This value should be greater than 1 Megohm when the unit is at room temperature.

If a low Megohm value exists, the following options may be used to dry the elements and return the Megohm value to an acceptable range:

The preferred method is to remove all terminal hardware and bake out the heater at no higher than 250°F (120°C) overnight or until an acceptable reading is reached. The second method is to energize the unit at low voltage in air until the megohm is at an acceptable reading. Care should be taken to prevent the heater sheath from exceeding 750°F (398°C) for Nickel alloy and steel elements.

Protection of heater elements from over temperature

The use of automatic temperature controls to regulate the heating process and prevent heater over temperature is highly recommended to ensure safe heater operation. All temperature limit devices must have appropriate third party approval and be applied in the classification for which it was tested and approved. The high temperature limiting device(s) should function independently from the process temperature control.

High Temperature Limit controllers with temperature feedback and relays that are independent from the heater control system can be used to provide an automatic means of interrupting the electrical power circuit when/if excessive temperatures occur.

WATLOW ELECTRIC MANUFACTURING COMPANY

Installation & Maintenance Manual for Screw Plug Heaters

I&M MANUAL No: 316-42-10-1

Date: 03/15/2017

Page: 8

Rev: 6.00



WARNING

It is the User's responsibility to ensure safety of the installation. Heaters are components of thermal systems. Unless otherwise provided by Watlow in writing, it is the User's responsibility to ensure that the thermal system is safe and that it performs as intended.

Install high temperature control protection in systems where an over temperature fault condition could present a fire or other hazard. Failure to install temperature control protection where a potential hazard exists could result in damage to equipment and property, and injury to personnel.

NOTE: Some heaters are supplied with thermocouples or thermostats, however it is still the responsibility of the User to properly use these devices in the control or protection circuit.



CAUTION

Failure of components in a temperature control loop, such as the sensor, heater control relay or main temperature control, can result in damage to a product in process, a meltdown of a heater, and/or damaging fire. To protect against this possibility, over temperature protection must be provided to interrupt or remove power from the heater circuit. To limit this risk, perform a functional test of all temperature limiting devices on a regular interval.

A bulb and capillary thermostat is not recommended for this function since it may not respond quickly enough to adequately protect the heater. In cases where the thermostat bulb gets too hot before the system is turned off, the thermostat bulb could rupture. This could result in the thermostat remaining in the "ON" condition since there is insufficient fluid to move contacts apart.



CAUTION

Ensure that the heater is installed in the correct orientation. The Hi limit sensor and baffle orientation (if so equipped) is critical!

In order to help prevent premature failure and a potentially hazardous condition in cases where consequences of failure may be severe, use an appropriate third party approved liquid level protection device. The liquid level should be such that the entire heater is fully submerged with enough liquid above the heater to adequately dissipate heat from itself as under normal operating conditions.

WATLOW ELECTRIC MANUFACTURING COMPANY

Installation & Maintenance Manual for Screw Plug Heaters

I&M MANUAL No: 316-42-10-1

Date: 03/15/2017

Page: 9

Rev: 6.00

Electrical Enclosures and Electrical Connection Protection



WARNING

If an enclosure is provided, it is the User's responsibility to determine the correct rating of the electrical (terminal) enclosure. This should be based on appropriate national and local electrical codes, as well as the environment in which the heater will be located. Failure to use a compatible enclosure could result in heater damage and personnel danger.

The User must ensure that any enclosure opening(s) are suitably glanded / filled / plugged to thus maintain the Type / IP environmental rating of the enclosure (after any wiring to the enclosure is completed).

In order to maintain termination integrity, it is the User's responsibility to keep the electrical enclosure temperature below 50°C (122°F) for units with thermostats. For all other units without a thermostat, the electrical enclosure temperature must be kept below 93°C (200°F).

Standard terminal enclosures are designed for general purpose (NEMA Type 1 / IP20). These enclosures should be applied where there will be no danger of spilled liquids, dampness, dirt, and gaseous conditions. Enclosures for wet locations are also available, but must be installed at the factory.

When enclosures are supplied over the terminals, units should be located in an area that will minimize the chance of being hit by falling or moving objects. The terminals must be protected at all times from moisture or vapor.

Orientation and Mounting



WARNING

Avoid incorrect handling and installation of the component parts. For example, do not lift the heater by the leadwires and avoid direct contact with fiberglass insulation.

WATLOW ELECTRIC MANUFACTURING COMPANY

Installation & Maintenance Manual for Screw Plug Heaters

I&M MANUAL No: 316-42-10-1

Date: 03/15/2017

Page: 10

Rev: 6.00



CAUTION

Heater orientation can be important in order to ensure intended heat transfer and safe operation. Refer to the documentation for the thermal system design for the proper orientation and ensure that the heater is installed accordingly. Observe any markings on the flange that may indicate required orientation, for example "TOP".

The Hi limit sensor and baffle orientation (if so equipped) is critical!

Care should be taken to allow enough room for heater expansion without compromising heat transfer.



WARNING

Electric heaters are capable of developing high temperatures, so to minimize the risk of fire extreme care should be taken to locate the heater in a safe location and environment.

Ensure that combustible materials are maintained far enough away from the Product to ensure that they are free of the effects of high temperatures.

This Product is not suitable for use in Hazardous (Classified) Locations.

Watlow screw plug immersion heaters typically incorporate a standard NPT plug for universal mounting in tanks equipped with the same size mounting coupling.

When installing the heater through the header on the tank, care should be taken to avoid bending the elements. If possible elements should be inspected to ensure that they are not touching. Failure to do so could result in shorter heater life due to higher heater temperatures.

The location of an immersion heater in a process is of prime importance. To take advantage of natural convection, the unit should be located as low as possible; similar to the position in Figure #1. Consideration should also be given to sludge build-up in the bottom of the tank and the need for heater removal (replacement or maintenance). Location of the heater in the sludge area will cause premature failure and lower heat transfer efficiency.

WATLOW ELECTRIC MANUFACTURING COMPANY

Installation & Maintenance Manual for Screw Plug Heaters

I&M MANUAL No: 316-42-10-1

Date: 03/15/2017

Page: 11

Rev: 6.00

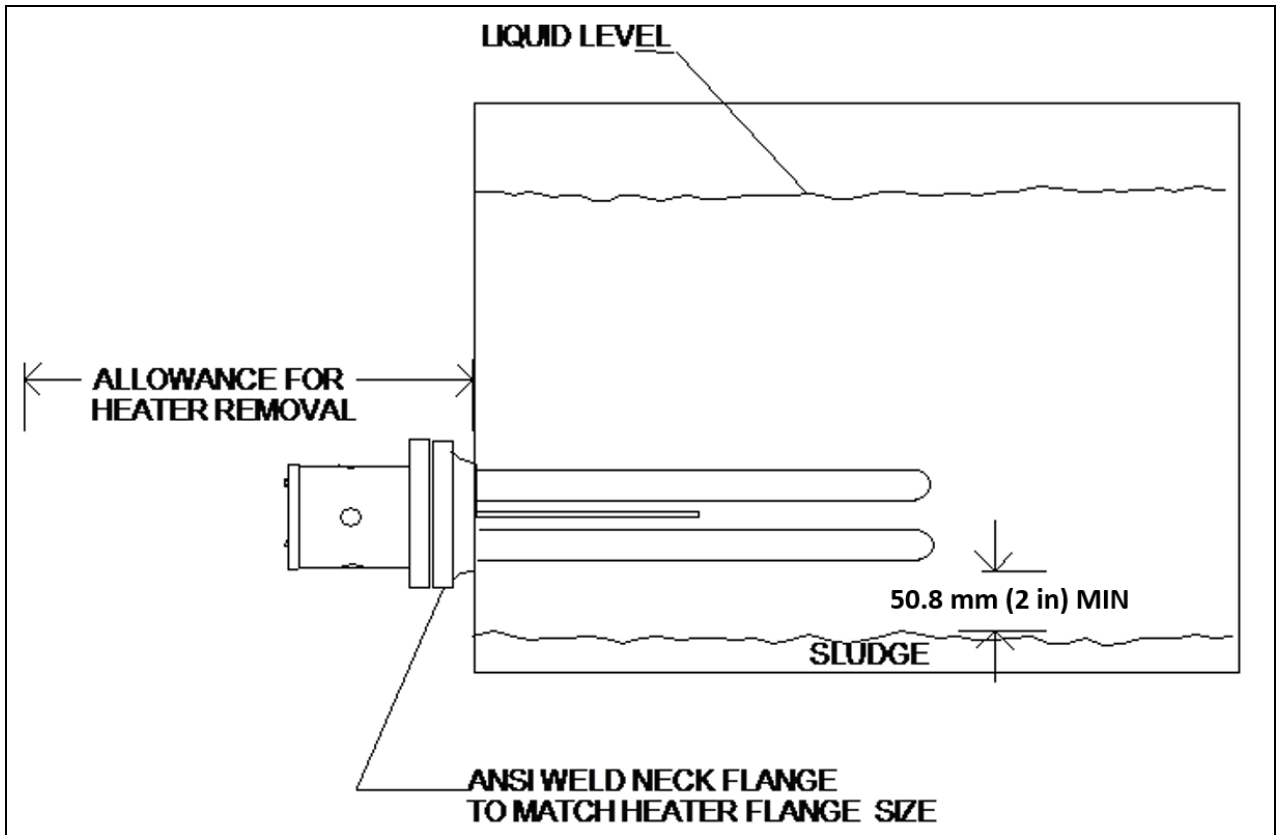
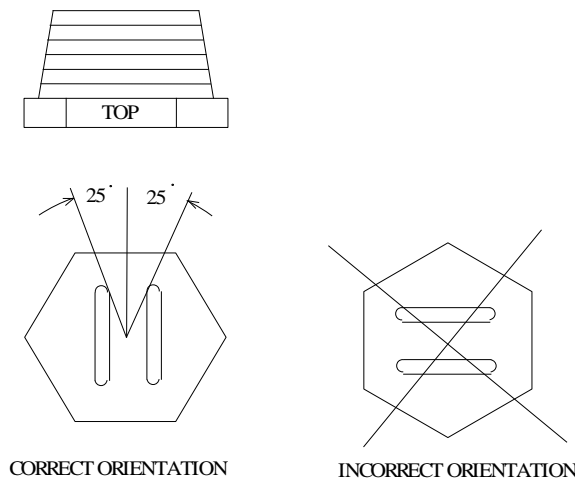

Figure # 1



Remove terminal enclosure to see element position

Figure # 2

WATLOW ELECTRIC MANUFACTURING COMPANY

Installation & Maintenance Manual for Screw Plug Heaters

I&M MANUAL No: 316-42-10-1

Date: 03/15/2017

Page: 12

Rev: 6.00

If a heater is being installed in a circulation tank, ensure safe installation and orientation (see Figure 2) of the heater in the tank. Failure to do this could result in premature heater failure due to improper fluid flow over elements.

Furnish adequate space for horizontal or vertical installation. Space should be allowed for immersion heater removal from tank.

Approved methods for installation of air (gas) and liquid units are shown in Figure # 3. Take careful note of the inlet and outlet locations. Consideration of inlet and outlet operating temperatures and their impact on expected terminal enclosure temperatures is recommended. Installation positions other than shown are not recommended.

Figure # 4 shows the preferred position of the circulation heater when pumping liquid from a tank through the heater. The NPSH (Net Positive Suction Head) is one of the most important factors when determining the location of the heater.

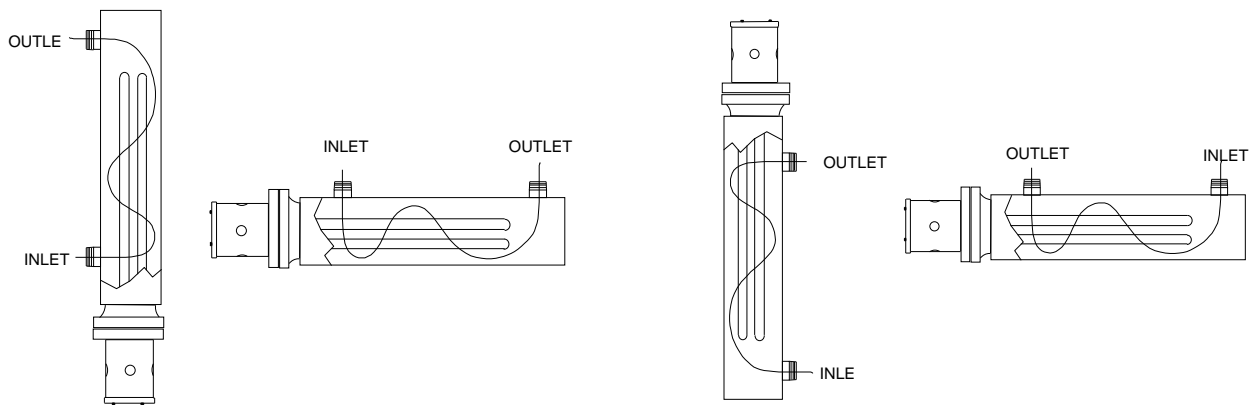

Figure # 3

WATLOW ELECTRIC MANUFACTURING COMPANY

Installation & Maintenance Manual for Screw Plug Heaters

I&M MANUAL No: 316-42-10-1

Date: 03/15/2017

Page: 13

Rev: 6.00

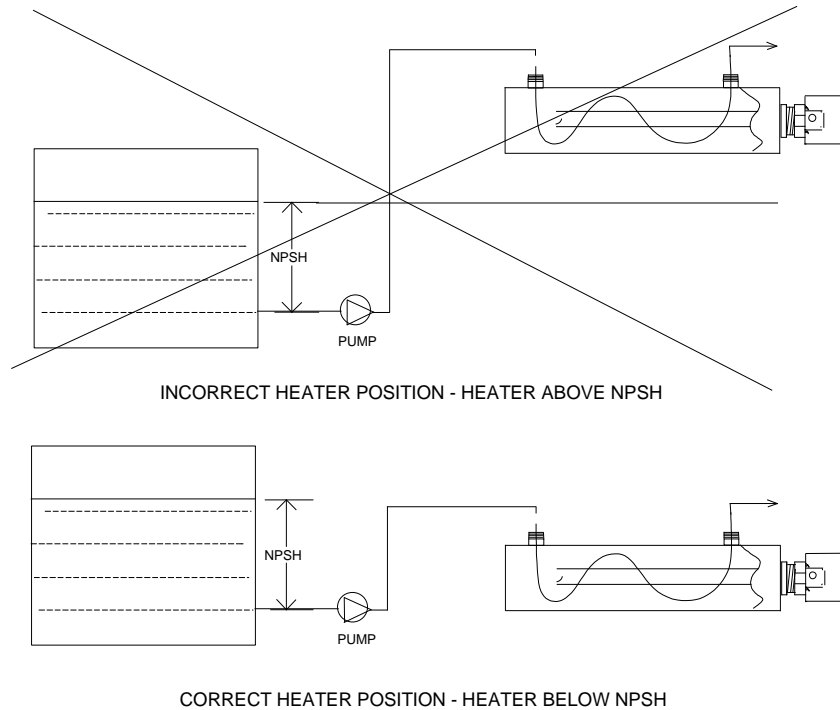

Figure # 4

When installing piping connections, care should be taken to avoid supporting the tank by the nozzles. Mounting blocks are provided to help prevent this. Provisions for thermal expansion and contraction should be considered, slotted bolt holes in one of the mating mounting pads would do adequately.

Installation of a pressure relief valve is recommended but not provided. If isolation valves are installed on the inlet and outlet piping, a pressure relief valve is required between the isolation valves to relieve any over-pressure of the heater vessel.

Wiring



WARNING

The User must ensure that the installer uses all relevant PPE (Personal Protection Equipment).

WATLOW ELECTRIC MANUFACTURING COMPANY

Installation & Maintenance Manual for Screw Plug Heaters

I&M MANUAL No: 316-42-10-1

Date: 03/15/2017

Page: 14

Rev: 6.00



WARNING – Risk of Electric Shock

The installation and wiring of this heater shall only be done by a qualified electrician, in accordance with applicable national and local electrical codes.

For heaters that do not already have insulated supply leads provided, the User must take action to cover any exposed conductive surfaces by adding suitable insulating material such as sleeving, heat shrink sleeve insulation, ceramic beads, etc.



WARNING – Risk of Electric Shock

Do not interrupt the protective earth circuit / ground.

Any interruption or disconnection of the protective earth circuit used by this heater will create a dangerous situation and could result in an electric shock that in some situations could lead to serious injuries!

If an enclosure is provided, this symbol indicates (shown below) where the protective earth ground should be connected in the electrical enclosure of the heater.



Electric heaters can be a source of stray current (aka leakage). Further, a short to ground is a common end-of-life failure mode for many kinds of electric heaters. To guard against injury or damage to equipment a GFI style circuit breaker selected to accommodate the electrical leakage during normal operation may need to be installed to ensure the safe operation of the heater.



WARNING – Risk of Electric Shock

It is the User's responsibility to properly size the ground wire for the Protective Earth / Safe Ground and to assure that the impedance of this is low enough to assure a person's safety.

WATLOW ELECTRIC MANUFACTURING COMPANY

Installation & Maintenance Manual for Screw Plug Heaters

I&M MANUAL No: 316-42-10-1

Date: 03/15/2017

Page: 15

Rev: 6.00



WARNING

It is the User's responsibility to properly size and install the feeder wires for the heater. Feeder wire should be properly selected based on amperage, electrical power rating, ambient temperature, and type of environment. Feeder wire should also be housed in either rigid or flexible conduit which carries the same classification as the electrical enclosure.

For heaters that do not already have insulated supply leads provided, the User must take action to cover any exposed conductive surfaces by adding suitable insulating material such as sleeving, heat shrink sleeve insulation, ceramic beads, etc

It is essential that these connections be tight. The top nut of the element stud terminals should be tightened to a maximum torque of 2.3 N-m (20 in-lbs) while the bottom nut is supported. NOTE: The top nut of stud terminals that do not have a buss bar or factory installed ring connector should only be tightened to 1 N-m (9 in-lbs).

It is the User's responsibility to ensure that the adjacent edge radii and bending radius of conductors/cables are large enough at the point of entry to prevent any damage and that connection of conductors, including their covering, shall be possible without risk of damage.

Consult the wiring diagram, if supplied with the heater, for the correct feeder wires connections. If one was not supplied with the heater, the system designer or the factory should be consulted for the appropriate wiring diagram.

Feeder wire line connections may be made directly to stud terminals, stud terminals will accept a M6 (#10) ring connector (T&B, Amp, etc.). A protective earth / ground connection terminal is also supplied inside the housing for ground wire. This terminal is painted "green" for easy identification within the electrical enclosure.



WARNING – Risk of Electric Shock

The Mains / Line voltage applied to the heater must always be equal to or less than the voltage rating marked on the heater's nameplate.

Some heaters are supplied as dual voltage (e.g. 240V / 480V) units and hence the User needs to check the wiring diagram supplied with the heater to ensure that the heater is wired correctly for their supply voltage. In most cases (unless specified by User) the heater as received will be wired for the higher operating voltage.

WATLOW ELECTRIC MANUFACTURING COMPANY

Installation & Maintenance Manual for Screw Plug Heaters

I&M MANUAL No: 316-42-10-1

Date: 03/15/2017

Page: 16

Rev: 6.00



WARNING – Risk of Electric Shock

If thermostats are supplied with the heater, they are for pilot duty use only. Consult specific product wiring diagram supplied with the heater for the allowable wiring of thermostats.

Thermostats should not be relied upon to remove electrical power for maintenance. The use of a disconnect switch or circuit breaker is highly recommended and will allow the isolation of the heater when maintenance is required.

Start Up

The following sets forth instructions and requirements relating to the initial startup of the Product(s).



CAUTION

Before energizing the heater the following items should have been checked with the Main / Line voltage disconnected. Failure to do so could result in damage to the heater when it is energized.

- 1. Electrical terminations are tight and wiring is per wiring diagram supplied with heater*
- 2. Proper disconnecting means and fusing have been installed*
- 3. The voltage rating of the heater is the same as that being applied*
- 4. Leg to Leg voltage is equal on 3 phase unit.*
- 5. Megohm value of the heater element(s) are within acceptable limits*
- 6. Proper temperature controls and safety limiting devices are in place with proper set point*
- 7. The heater is securely installed in tank header and no leaks are visible*
- 8. The heater is properly grounded.*
- 9. For liquid immersion applications, ensure that the immersed section of heater is completely covered by liquid.*
- 10. For circulating type applications, assure that the correct fluid/gas flow has been started and is being maintained over the heater bundle to ensure that heater elements do not overheat and fail once the heater is energized.*

WATLOW ELECTRIC MANUFACTURING COMPANY

Installation & Maintenance Manual for Screw Plug Heaters

I&M MANUAL No: 316-42-10-1

Date: 03/15/2017

Page: 17

Rev: 6.00



WARNING

After restarting the system and enabling power to be applied to the heater in normal operating mode, make sure that the system is being controlled properly before leaving it to run unattended. Failure to do this could result in the heater overheating in a “run away” condition that could lead to damage to equipment, fire or personal injury.

NOTE: Thermal cycling may cause sealing joints to relax causing a leak. Exercise caution when tightening the screw plug to prevent thread damage and maintain correct plug orientation.

Troubleshooting

The information provided below contains potential causes and corrections for functional problems with the Product(s). This is a nonexhaustive list of potential problems and corrections and is not meant to cover all potential issues. Please do not hesitate to contact your Watlow representative if you have any questions regarding the performance of your Product(s).



WARNING – Risk of Electric Shock

High voltage is present when the heater is energized and hence troubleshooting of this heater shall only be done by qualified personnel. It is the User’s responsibility to ensure that proper precautions are taken in reference to applicable personal protective equipment (PPE) needed by those installing and maintaining equipment.

WATLOW ELECTRIC MANUFACTURING COMPANY

Installation & Maintenance Manual for Screw Plug Heaters

I&M MANUAL No: 316-42-10-1

Date: 03/15/2017

Page: 18

Rev: 6.00

PROBLEM	Cause / Correction
No power available to heater	Check disconnect switch to ensure it is in the "ON" position And that fuses are not blown. Replace fuses if they are blown
Fuses blowing	Check heater electrical rating. Applied voltage may be wrong Check fuse rating. Fuses should be at least 25% more than full Load Amperage Disconnect heater power source. Check the heater resistance To ground. This should be no less than 1 Megohm. Refer to Megohm checking. Check heater enclosure for loose or oxidized connections. repair and tighten as necessary Check heater enclosure for presence of condensation. Conduit seals or drains may be required
Not enough power	Check line voltage to ensure it is within specification Check full line current if voltage is correct. If line current is lower, the heater may be wired wrong or has open elements
Fluid not heating to desired Temperature	Not enough Kw Too much heat loss
High limit tripping / alarm	Not enough fluid flow Too much kW Line voltage higher than designed / allowable

Preventative Maintenance



WARNING

The User must ensure that the installer uses all relevant PPE (Personal Protection Equipment).

WATLOW ELECTRIC MANUFACTURING COMPANY

Installation & Maintenance Manual for Screw Plug Heaters

I&M MANUAL No: 316-42-10-1

Date: 03/15/2017

Page: 19

Rev: 6.00



WARNING – Risk of Electric Shock

High voltage is present when the heater is energized and hence preventative maintenance of this heater shall only be done by qualified personnel.

Turn all power off to the heater and “Lock Out / Tag Out” the power disconnect switch(es) for the heater before performing any preventative maintenance.

It is the User’s responsibility to ensure that proper precautions are taken in reference to applicable personal protective equipment needed by those installing and maintaining equipment.



WARNING

The heater, vessel and system can remain hot for a long period of time after the power has been removed, so make sure the equipment has cooled down to a safe temperature before performing any preventative maintenance.



WARNING – Risk of Electric Shock

If a non-cast enclosure is provided, the terminal enclosure cover is bonded to enclosure body to ensure an effective ground fault current path. If this bonding conductor is disconnected for any reason it must be reconnected for safety. The typical connection utilizes two external tooth lockwashers to sandwich the conductor ring terminal against the connection base and the tightening nut/screw. All hardware must be replaced. Retighten connections to 2.3 N·m (20 in-lb).

Thermal cycling, corrosion and vibration can cause degradation of thermal system and electrical interfaces. Follow system designer’s guidelines for periodic checking the condition of the installed heater and the electrical connections.

Check line connections on a regular basis (6 months recommended) to make sure they are tight, free of oxide build-up, and that no dust or dirt build-up is present. Retighten as necessary per the instruction found in Wiring Section of this manual.

If an enclosure is provided, check enclosure (inside) for rust, dirt or dust. Remove rust if present, with steel wool (or equal) and thoroughly blow clean with dry, oil-free air. If enclosure is moisture resistant, check condition of cover gasket. If the gasket is damaged or is in need of replacement, please contact the factory for further assistance in resolving this issue.

Liquid immersed units should be removed from tank and checked periodically for scale build-up. Clean as required. Scale can cause high sheath temperature and result in inefficiency and shortened life.

WATLOW ELECTRIC MANUFACTURING COMPANY

Installation & Maintenance Manual for Screw Plug Heaters

I&M MANUAL No: 316-42-10-1

Date: 03/15/2017

Page: 20

Rev: 6.00

Thermal cycling may cause sealing joints to relax causing a leak. Exercise caution when tightening the screw plug to prevent thread damage and maintain correct plug orientation.

Replacement Parts

Please contact a Watlow representative directly to order additional or replacement parts. If your Watlow representative is not known, please visit our website <http://www.watlow.com> and use the interactive "Sales & Distributor Locator" tool to identify and contact your local Watlow distributor for ordering replacement parts.

When ordering any additional or replacement products from Watlow, please reference the part number, which should be located on the Product's marking, nameplate or tag.

Disposal and Recycling

Heaters are classified under the RoHS and WEEE directives as electronic components with respect to disposal, and as such, must be recycled as per the requirements of the national regulations of the End User.



WATLOW ELECTRIC MANUFACTURING COMPANY

Installation & Maintenance Manual for Screw Plug Heaters

I&M MANUAL No: 316-42-10-1

Date: 03/15/2017

Page: 21

Rev: 6.00

Terms and Conditions and Product Returns

Unless otherwise expressly agreed to in writing by Watlow, Watlow's standard terms and conditions shall apply to your purchase and use of the Product in all respects. Such terms and conditions include, but are not limited to applicable warranty obligations and payment terms. The terms and conditions may be found attached to any order acceptance or bid prepared by Watlow. For a copy of such terms and conditions, please contact Watlow's customer service department.

In the event that you desire to make a warranty claim against any Product because it does not comply with the warranty provisions provided under the applicable terms and conditions, please contact Watlow customer service to obtain a Return Material Authorization (RMA) number before returning any item for repair or replacement. The following information is needed to process a returned Product expeditiously:

- Customer name
- Contact Name
- Part number
- Quantity
- Reason for return
- MSDS sheet of material(s) that came in contact with heater, if used.
- Customer account number
- Phone Number
- E-mail Address
- P.O. number
- Application information

Prior approval and an RMA number are required when returning any unused Product for credit. Make sure the RMA number is on the outside of the carton, and on all paperwork. Return all material on a Freight prepaid basis.

Stock Products which have not been used or modified can be returned to Watlow for a 20% restocking charge. Modified stock units can only be returned if they are not permanently modified, for a minimum 30% restocking charge. Please contact Watlow customer service for further instructions. All stock and modified stock Products must have a date code no later than 2 years from the date of shipment in order for Watlow to accept such returns.

WATLOW ELECTRIC MANUFACTURING COMPANY

Installation & Maintenance Manual for Screw Plug Heaters

I&M MANUAL No: 316-42-10-1

Date: 03/15/2017

Page: 22

Rev: 6.00

Declaration of Conformity (page 1)

	
CE DECLARATION OF CONFORMITY	
Manufacturer:	
Watlow Electric Manufacturing Company 6 Industrial Loop Road Hannibal, MO 63401	
Product Families:	
WATROD™ Heater, FIREBAR® Heater, Screw Plug Heater, Duct Heater, Flange Heater, MULTICELL™ Heater, ECO-HEAT® Heater, and Over-the-Side Heater.	
SEE OPPOSITE SIDE FOR PRODUCT DESIGNATION	
Description:	
Metal-Sheathed Heating Elements and Heating Assemblies	
We, as the manufacturer, hereby declare that the Products described above (and on the opposite side), are in conformity with the applicable requirements in accordance with the following European Directive(s):	
Low Voltage Directive 2014/35/EU RoHS Directive 2011/65/EU	
The object of the declarations described above is in conformity with the relevant Union harmonization legislation. This declaration of conformity is issued under the sole responsibility of the manufacturer for the aforementioned product(s).	
The following Harmonized Standard(s) and normative references were complied with -	
BS EN 60335-1:2012+A11:2014 - Safety of household and similar electrical appliances	
EN 50581:2012 - Technical documentation for the assessment of electrical and electronic products with respect to the restriction of hazardous substances	
European person authorized to compile the Technical File, on behalf of the Manufacturer, is:	
Martin Wallinger Watlow Plasmatech GmbH Brennhoflehen-Kellau 156 5431, Kuehl, Austria +43 8244 20129-0	
Signed for and on behalf of:	
Watlow Electric Manufacturing Company 6 Industrial Loop Road Hannibal, MO 63401	
Name of Signatory: Jana Yarrington	Signature:
Function/Position: Director of Operations	Date: March 22, 2017
CE 226-0-5-39 Rev 014	Page 1 of 2 CE

WATLOW ELECTRIC MANUFACTURING COMPANY

Installation & Maintenance Manual for Screw Plug Heaters

I&M MANUAL No: 316-42-10-1

Date: 03/15/2017

Page: 23

Rev: 6.00

Declaration of Conformity (page 2)

CE	CE
Product Designation:	
<u>Catalog Product(s) Code Number(s)</u>	<u>Description</u>
Series R, may be followed by additional letters and numbers	WATROD Element
Series F, may be followed by additional letters and numbers	FIREBAR Element
Series B, may be followed by additional letters and numbers	Screw Plug Heater
Series D, LDH, MDH may be followed by additional letters and numbers	Duct Heater
Series F, may be followed by additional letters and numbers	Flange Heater
Series MX or TX, may be followed by additional letters and numbers.	MULTICELL Heater
Series EH, may be followed by additional letters and numbers	ECO-HEAT
Series O and V, may be followed by additional letters	Over-the-Side Heater

The above table describes typical catalog model designations. Custom products are defined with a part number as shown below. The part number prefix typically designates the base element construction. May also be preceded by the letter "U".

Prefix	DESCRIPTION
0	0.210 in. (5.3 mm) dia. WATROD
1	0.260 in. (6.6 mm) dia. WATROD
2	1-Inch FIREBAR 1.010 in (25.7 mm) height X 0.235 in. (5.9 mm) thickness
3	0.315 in. (8.0 mm) dia. WATROD
4	5/8-Inch FIREBAR 0.650 in. (16.5 mm) height X 0.235 in. (5.9 mm) thickness
5	0.375 in. (9.5 mm) dia. WATROD
6	0.430 in. (10.9 mm) dia. WATROD
7	0.475 in. (12.1 mm) dia. WATROD
8	0.490 in. (12.5 mm) dia. WATROD

The number following the first dash typically designates the product family and/or application as shown below:

Miscellaneous application with WATROD or FIREBAR as base element construction:
2, 3, 4, 5, 9, 10, 11, 12, 13, 14, 15, 16, 17, 28, 29, 31, 32, 33, 34, 35, 45, 46, 47, 48, 49, 50, 51, 55, 56

Screw Plug Heater: 36, 38, 39, 41, 43, 44

Duct Heater: 1

Flange Heater: 18, 21, 22, 23, 26, 27 or alternately 700 Series (700-799) followed by 2 digit date and three digit sequence number (7XX-YYSSS)

MULTICELL Heater may be designated with 9xxx, or 10xxx part number only.

ECO-HEAT: 67

Over-the-Side Heater: 30

| CE | 226-0-5-39 Rev 014 | Page 2 of 2 | CE |

WATLOW ELECTRIC MANUFACTURING COMPANY

Installation & Maintenance Manual for Screw Plug Heaters

I&M MANUAL No: 316-42-10-1

Date: 03/15/2017

Page: 24

Rev: 6.00

THIS PAGE LEFT INTENTIONALLY BLANK